

DESCRIPTION

The HY62C256 is a high speed low power, 32,768 words by 8-bit CMOS static RAM fabricated using HYUNDAI's high performance twin tub CMOS process. This high reliability process coupled with innovative circuit design techniques, yields maximum access time of 85ns.

The HY62C256 has a data retention mode that guarantees data will remain valid at a minimum power supply voltage of 2.0 volt.

Using CMOS technology, supply voltages from 2.0 to 5.5 volt have little effect on supply current in data retention mode. Reducing the supply voltage to minimize current drain is unnecessary with the HY62C256 family.

FEATURES

- High speed — 85/100/120/150 ns (max.)
- Low power consumption
 - 175mW typical operating
 - 15 μ W typical standby (L-version)
- Battery back up (L-version)
 - 2 volt data retention
- Fully static operation
 - No clock or refresh required
- All inputs and outputs directly TTL compatible
- Tri-state output
- High reliability 28 pin 600 mil P-DIP and 330 mil SOP

	HY62C256-85	HY62C256-10	HY62C256-12	HY62C256-15
Maximum Access Time (ns)	85	100	120	150
Maximum Average Operating Current (mA)	70	70	70	70
Maximum Standby Current (mA)		1.0	1.0	1.0
	L	0.1	0.1	0.1

BLOCK DIAGRAM

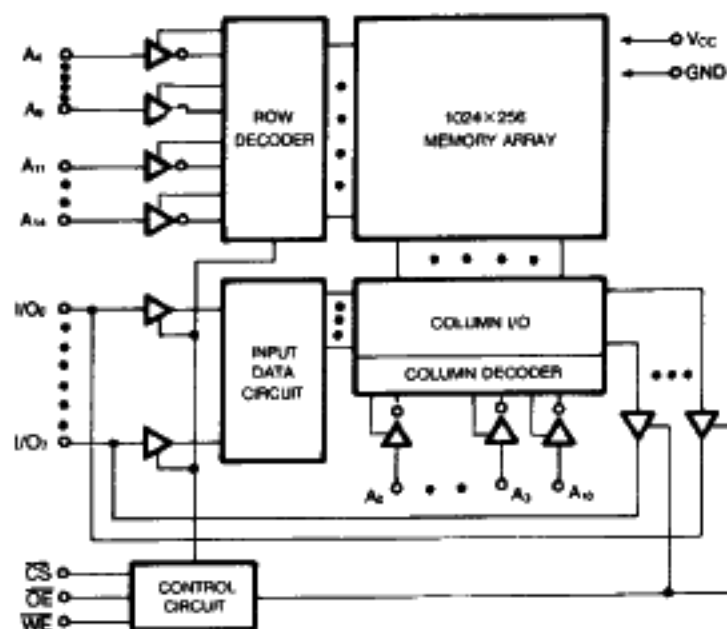

PIN CONNECTIONS

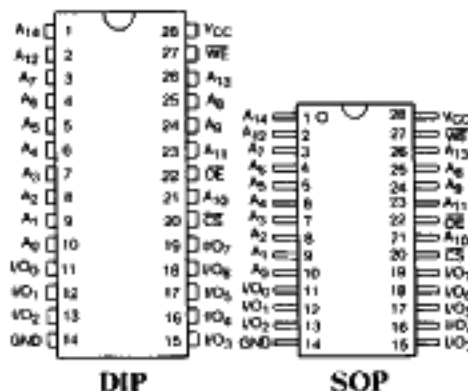

PIN NAMES

A ₀ -A ₁₄	ADDRESS INPUT
IO ₀ -IO ₇	DATA INPUT / OUTPUT
CS	CHIP SELECT
WE	WRITE ENABLE
OE	OUTPUT ENABLE
V _{cc}	POWER
GND	GROUND

T-46-23-13

ABSOLUTE MAXIMUM RATINGS⁽¹⁾

SYMBOL	PARAMETER	RATING	UNIT
V _{DD} , V _{IN} , V _{IO}	Power Supply, Input, Input/Output Voltage	-0.5 ⁽²⁾ to 7.0	V
T _{BIAS}	Temperature Under Bias	-10 to 125	°C
T _{STG}	Storage Temperature	-65 to 150	°C
P _D	Power Dissipation	1.0	W
I _{OUT}	Data Output Current	50	mA

NOTES:

1. Stresses greater than those listed under ABSOLUTE MAXIMUM RATINGS may cause permanent damage to the device. This is a stress rating only and functional operation of the device at these or any other conditions above those indicated in the operational sections of this specification is not implied. Exposure to absolute maximum rating conditions for extended may affect reliability.

2. -3.5V for 20ns pulse.

RECOMMENDED DC OPERATING CONDITIONS

(T_A=0°C to 70°C)

SYMBOL	PARAMETER	MIN.	TYP.	MAX.	UNIT
V _{CC}	Supply Voltage	4.5	5.0	5.5	V
V _{IH}	Input High Voltage	2.2	3.5	6.0	V
V _{IL}	Input Low Voltage	-0.5 ⁽¹⁾	-	0.8	V

NOTE:

1. -3.5V for 20 ns pulse.

TRUTH TABLE

MODE	$\overline{\text{CS}}$	$\overline{\text{OE}}$	$\overline{\text{WE}}$	I/O OPERATION
Standby	H	X	X	High-Z
output Disabled	L	H	H	High-Z
Read	L	L	H	D _{OUT}
Write	L	X	L	D _{IN}

NOTE:

1. X: H or L

DC CHARACTERISTICS

(V_{CC}=5V±10%, T_A=0°C to 70°C)

SYMBOL	PARAMETER	TEST CONDITIONS	HY62C56			UNIT
			MIN.	TYP. ⁽¹⁾	MAX.	
I _{IL}	Input Leakage Current	V _{IN} =GND to V _{CC}	-	-	2	μA
I _{IO}	Output Leakage Current	$\overline{CS}=V_{IH}$, $\overline{OE}=V_{IH}$ or $\overline{WE}=V_{IL}$, V _{IO} =GND to V _{CC}	-	-	2	μA
I _{CC}	Operating Power Supply Current	$\overline{CS}=V_{IL}$, I _{IO} =0mA	-	40	70	mA
I _{CC1}	Average Operating Current	$\overline{CS}=V_{IL}$, Min. Duty Cycle=100%	-	35	70	mA
I _{SB}	Standby Power Supply Current	$\overline{CS}=V_{IH}$	-	-	1.0	mA
I _{SB1}		$\overline{CS} \geq V_{CC}-0.2V$.	L	-	3	100
V _{OL}	Output Low Voltage	I _{OL} =4mA	-	-	0.4	V
V _{OH}	Output High Voltage	I _{OH} =-1.0mA	2.4	-	-	V

NOTE:

1. V_{CC}=5V, T_A=25°C

AC CHARACTERISTICS

(V_{CC}=5V±10%, T_A=0°C to 70°C)

READ CYCLE

SYMBOL	PARAMETER	HY62C256-85		HY62C256-10		HY62C256-12		HY62C256-15		UNIT
		MIN.	MAX.	MIN.	MAX.	MIN.	MAX.	MIN.	MAX.	
t _{RC}	Read Cycle Time	85	-	100	-	120	-	150	-	ns
t _{AA}	Address Access Time	-	85	-	100	-	120	-	150	ns
t _{ACH}	Chip Select Access Time	-	85	-	100	-	120	-	150	ns
t _{CLZ}	Chip Selection to Output in Low-Z	5	-	5	-	5	-	5	-	ns
t _{OE}	Output Enable to Output Valid	-	45	-	50	-	60	-	70	ns
t _{OLZ}	Output Enable to Output in Low-Z	5	-	5	-	5	-	5	-	ns
t _{CHZ}	Chip Deselection to Output in High-Z	0	30	0	35	0	40	0	50	ns
t _{OHZ}	Output Disable to Output in High-Z	0	30	0	35	0	40	0	50	ns
t _{OH}	Output Hold from Address Change	5	-	10	-	10	-	10	-	ns

T-46-23-13

WRITE CYCLE

SYMBOL	PARAMETER	HY62C256-85		HY62C256-10		HY62C256-12		HY62C256-15		UNIT
		MIN.	MAX.	MIN.	MAX.	MIN.	MAX.	MIN.	MAX.	
t _{wc}	Write Cycle Time	85	—	100	—	120	—	150	—	ns
t _{cw}	Chip Selection to End of Write	75	—	80	—	85	—	100	—	ns
t _{aw}	Address Valid to End of Write	75	—	80	—	85	—	100	—	ns
t _{as}	Address Set-up Time	0	—	0	—	0	—	0	—	ns
t _{wp}	Write Pulse Width	60	—	70	—	70	—	90	—	ns
t _{wr}	Write Recovery Time	0	—	0	—	0	—	0	—	ns
t _{ohz}	Output Disable to Output in High-Z	0	30	0	35	0	40	0	50	ns
t _{whz}	Write to Output in High-Z	0	30	0	35	0	40	0	50	ns
t _{pw}	Data to Write Time Overlap	40	—	40	—	50	—	60	—	ns
t _{ph}	Data Hold from Write Time	0	—	0	—	0	—	0	—	ns
t _{ow}	Output Active from End of Write	5	—	10	—	10	—	10	—	ns

AC TEST CONDITIONS

(T_A=0°C to 70°C)

Input Pulse Level	0.8V to 2.4V
Input Rise and Fall Time	5ns
Input and Output Timing Reference Levels	1.5V

OUTPUT LOAD

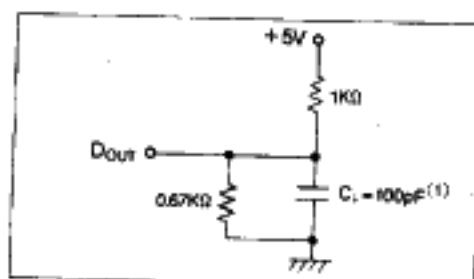

NOTE:
1. Including scope and the jig.

CAPACITANCE

(T_A=25°C, f=1.0 MHz)

SYMBOL	PARAMETER	CONDITIONS	MAX.	UNIT
C _{IN}	Input Capacitance	V _{IN} =0V	8	pF
C _{I/O}	Input/Output Capacitance	V _{IO} =0V	10	pF

NOTE:

1. This parameter is sampled and not 100% tested.

T-46-23-13

TIMING DIAGRAMS

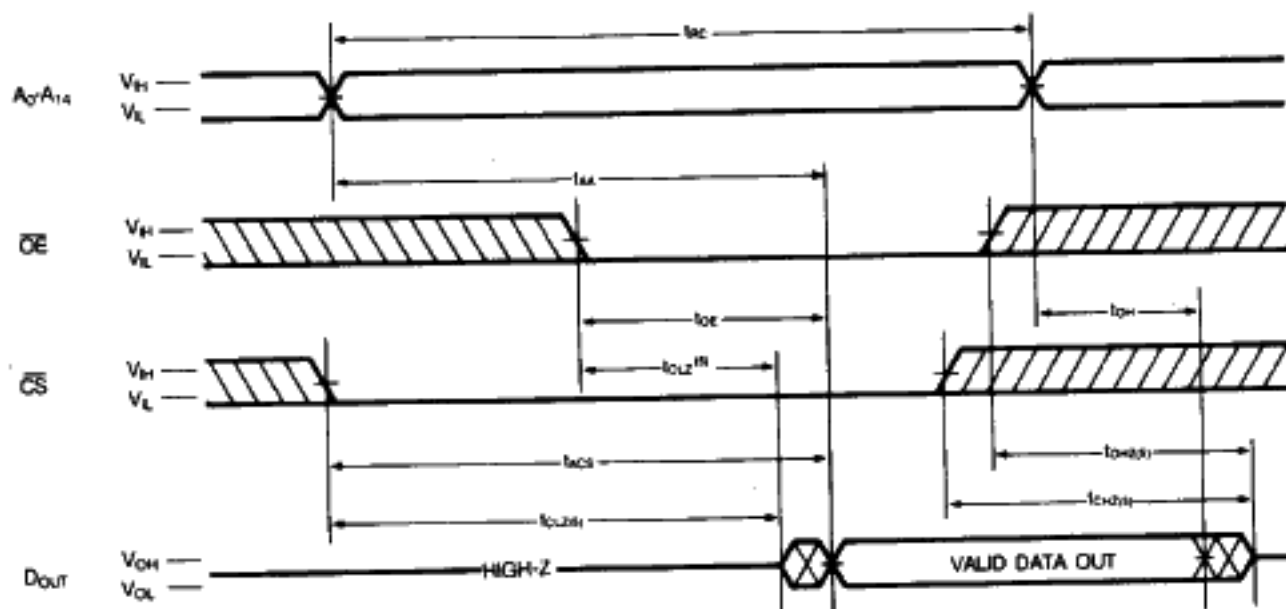
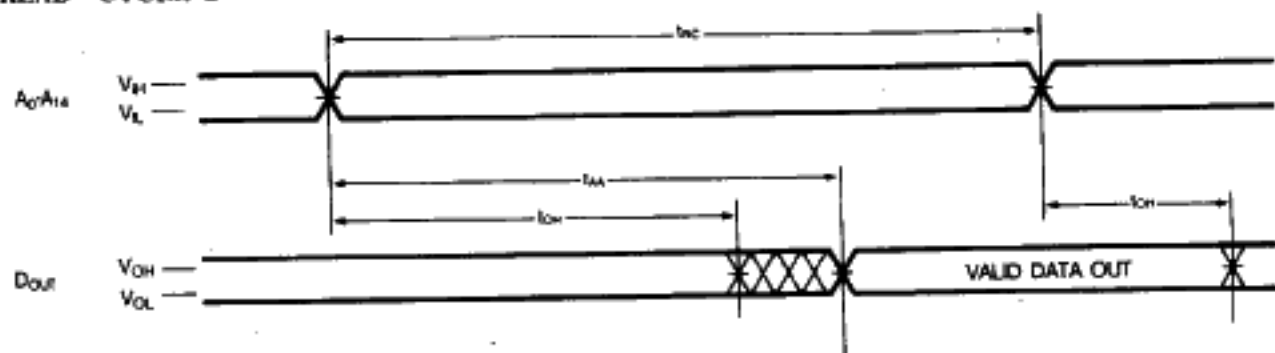
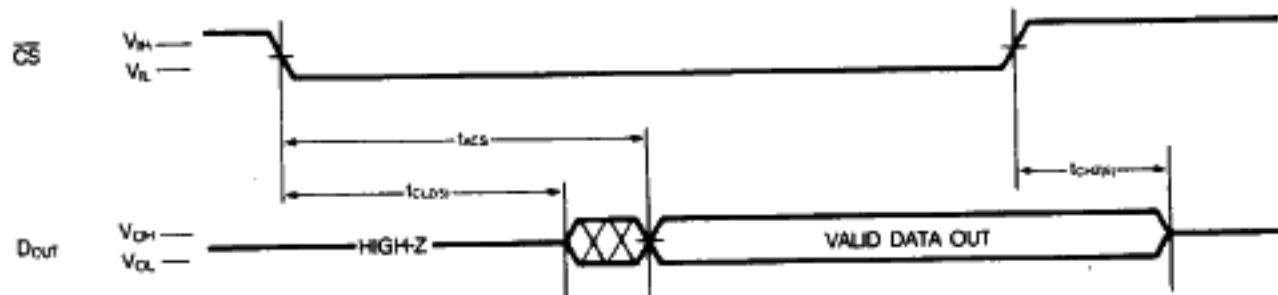
READ CYCLE 1⁽¹⁾READ CYCLE 2^(1, 2, 4)READ CYCLE 3^(1, 3, 4)

NOTES:

1. WE is high for Read Cycle.
2. Device is continuously selected. $\overline{CS} = V_{IL}$.
3. Addresses are valid prior to or coincident with \overline{CS} transition low.
4. $\overline{OE} = V_{IL}$.
5. Transition is measured $\pm 500\text{mV}$ from steady state. This parameter is sampled and not 100% tested.

HY62C256 32,768×8-Bit CMOS SRAM

T-46-23-13

WRITE CYCLE 1

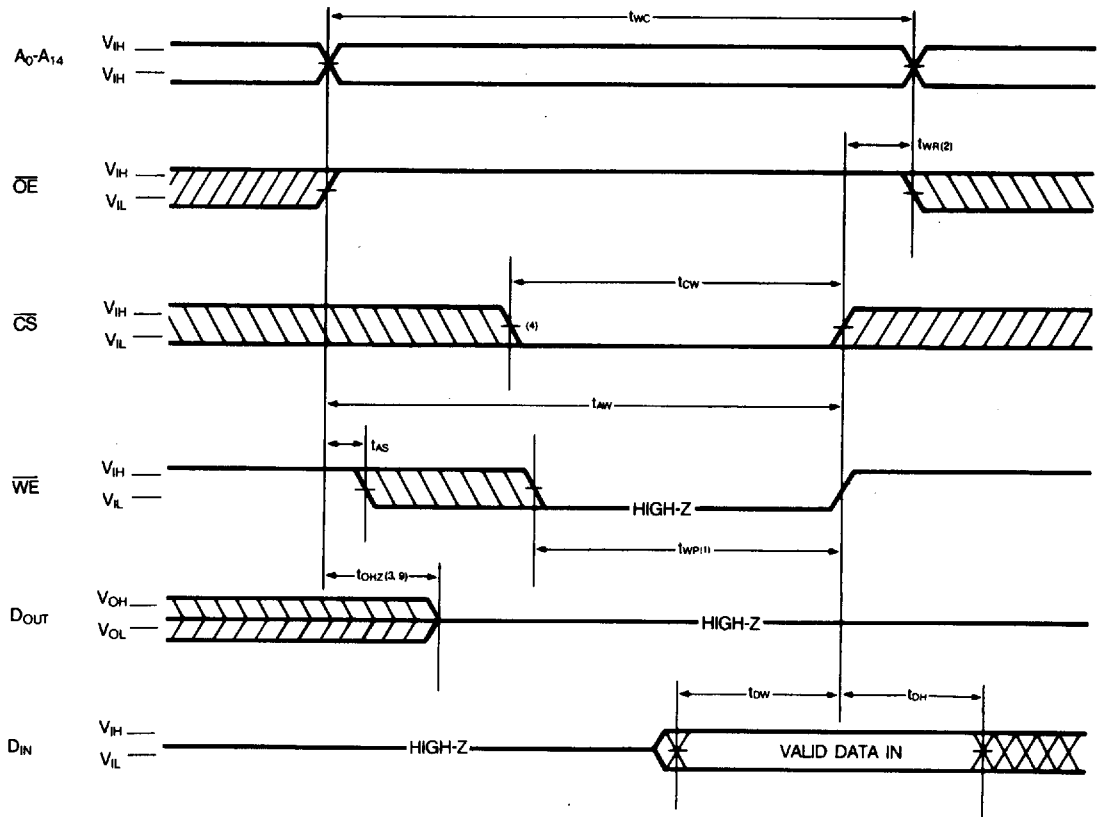

HY62C256 32,768×8-Bit CMOS SRAM

T-46-23-13

WRITE CYCLE 2⁽⁵⁾

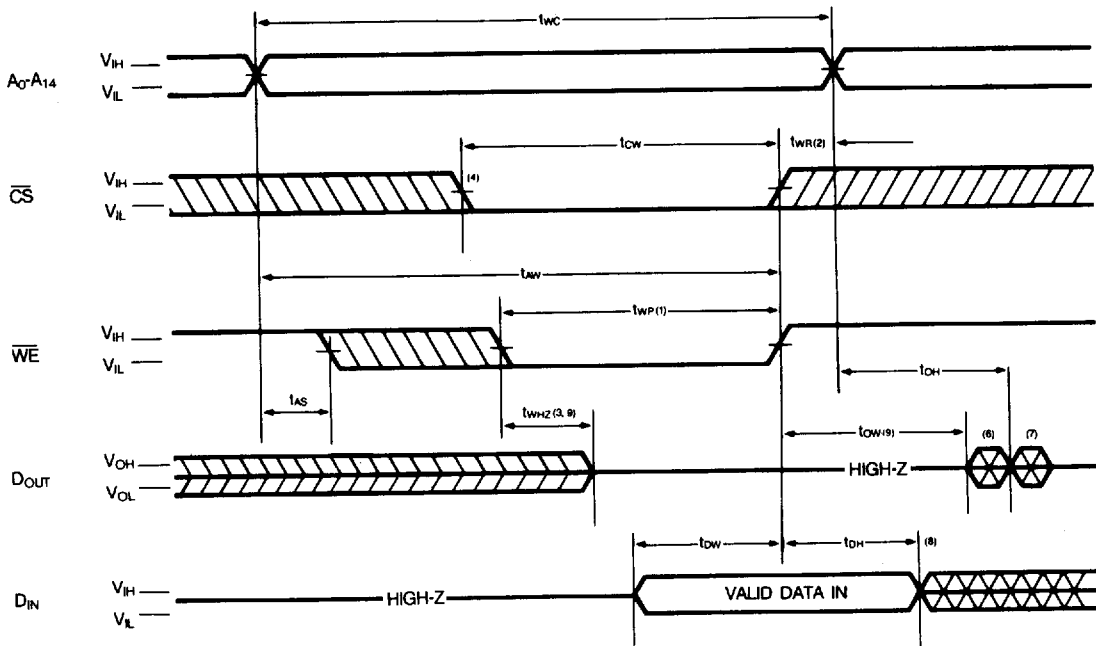

NOTES :

1. A write occurs during the overlap (t_{WP}) of low \overline{CS} and low \overline{WE} .
2. t_{WR} is measured from the earlier of \overline{CS} or \overline{WE} going high at the end of write cycle.
3. During this period, I/O pins are in the output state so that the input signals of opposite phase to the outputs must not be applied.
4. If the \overline{CS} low transition occurs simultaneously with the \overline{WE} low transitions or after the \overline{WE} transition, outputs remain in a high impedance state.
5. \overline{OE} is continuously low ($\overline{OE} = V_{IL}$).
6. D_{OUT} is the same phase of write data of this write cycle.
7. D_{OUT} is the read data of next address.
8. If \overline{CS} is low during this period, I/O pins are in the output state. Then the data input signals of opposite phase to the outputs must not be applied to them.
9. Transition is measured $\pm 500mV$ from steady state. This parameter is sampled and not 100% tested.

HY62C256 32,768×8-Bit CMOS SRAM

T-46-23-13

DATA RETENTION CHARACTERISTICS⁽¹⁾

(T_A=0°C to 70°C)

SYMBOL	PARAMETER	TEST CONDITIONS	MIN.	TYP.	MAX.	UNIT
V _{DR}	Data Retention Supply Voltage	V _{IN} =0 to V _{CC} , $\overline{CS} \geq V_{CC}-0.2V$	2.0	-	-	V
I _{CCDR}	Data Retention Current	V _{CC} =3.0V, V _{IN} =0 to V _{CC} , $\overline{CS} \geq V_{CC}-0.2V$	-	2	50	μA
t _{CDR}	Chip Deselect to Data Retention Time	See Data Retention Timing Diagram	0	-	-	ns
t _r	Operating Recovery Time		t _{RC} ⁽²⁾	-	-	ns

NOTES :

1. These characteristics are guaranteed for L-version.
2. t_{RC}=Read Cycle Time

DATA RETENTION TIMING DIAGRAM

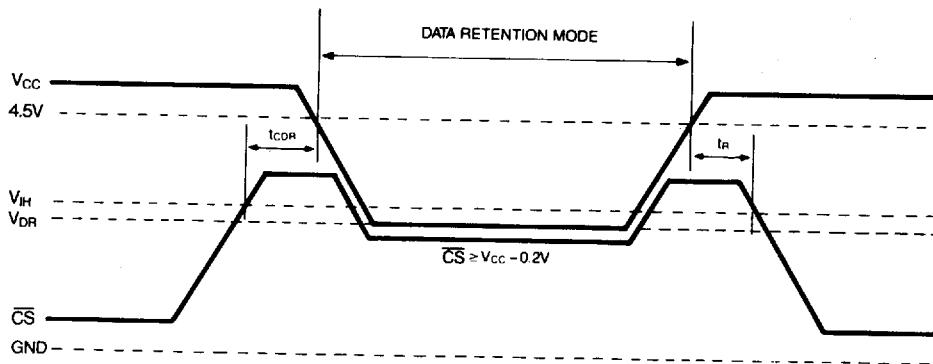

T-46-23-13

ELECTRICAL CHARACTERISTIC CURVES

($V_{CC}=5V$, $T_A=25^{\circ}C$, unless otherwise noted)

SUPPLY CURRENT vs. SUPPLY VOLTAGE

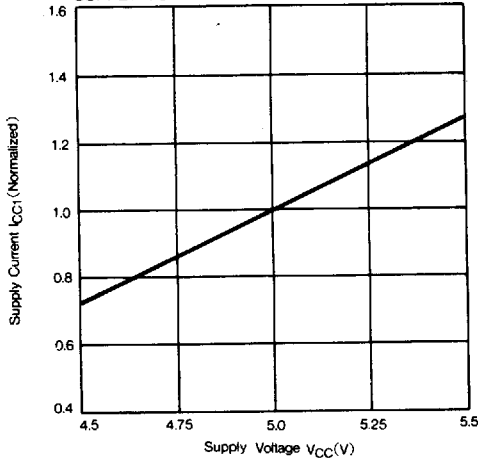

SUPPLY CURRENT vs. AMBIENT TEMPERATURE

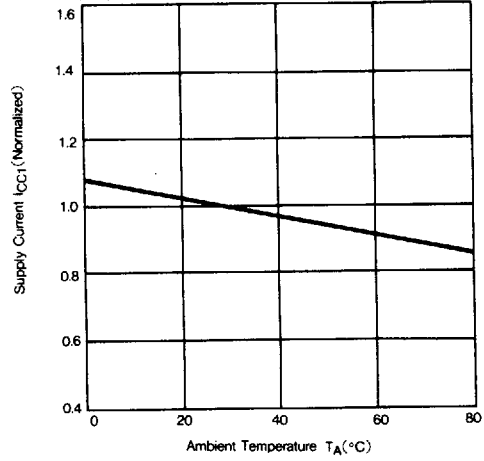

ACCESS TIME vs. SUPPLY VOLTAGE

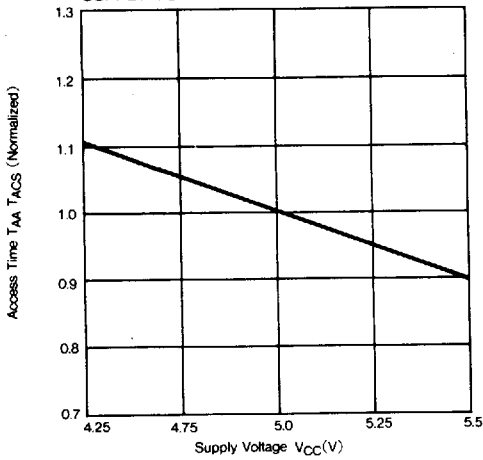

ACCESS TIME vs. AMBIENT TEMPERATURE

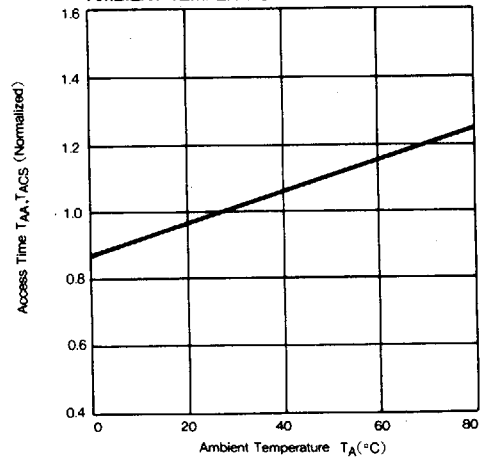

INPUT LOW VOLTAGE vs. SUPPLY VOLTAGE

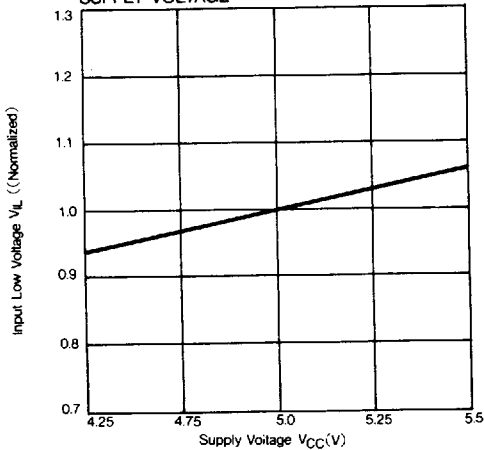

INPUT HIGH VOLTAGE vs. SUPPLY VOLTAGE

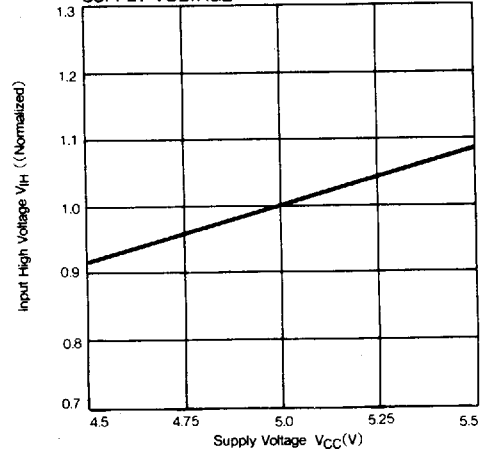

5

HY62C256 32,768×8-Bit CMOS SRAM

T-46-23-13

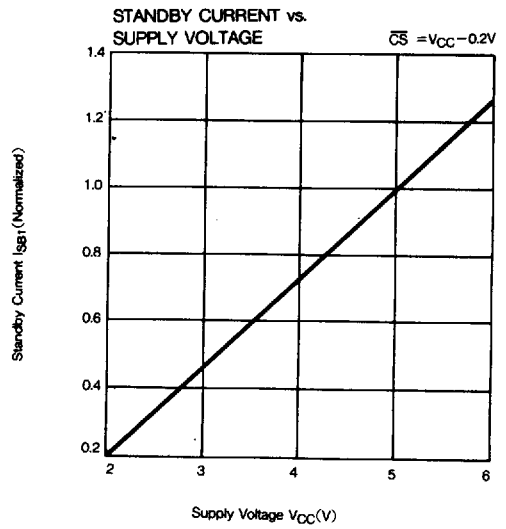
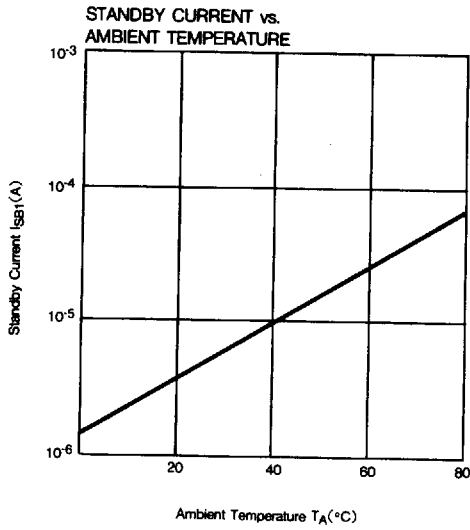
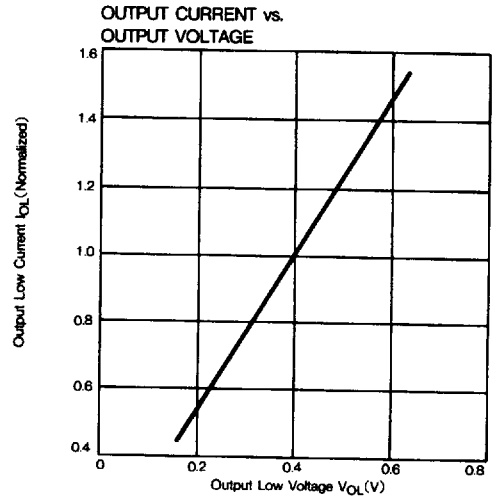
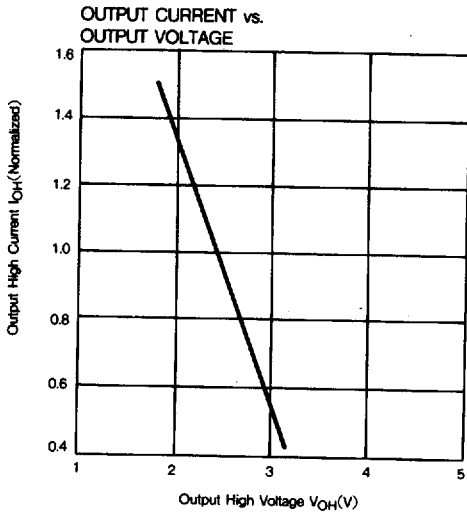

T-46-23-13

PACKAGE INFORMATION

• 28 PIN PLASTIC DUAL IN LINE PACKAGE-600MIL

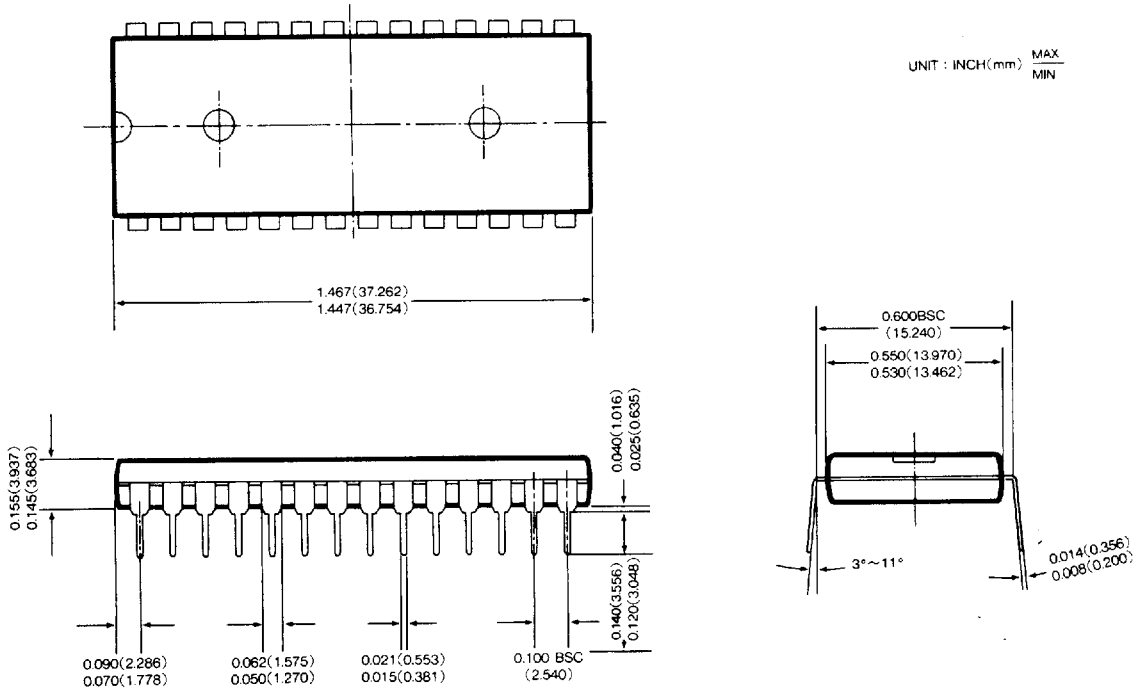

• 28 PIN SMALL OUTLINE PACKAGE-330MIL

